

FITTING INSTRUCTION

| Clamp mark in acc. with | | Cables joining |
|-------------------------|-----|---------------------------|
| ISO | PN | |
| 1 | L | Left directional lights |
| 2 | + | Rear fog lights |
| 3 | 31 | Ground |
| 4 | R | Right directional lights |
| 5 | 58R | Right side parking lights |
| 6 | 54 | Stoplights |
| 7 | 58L | Left side parking lights |

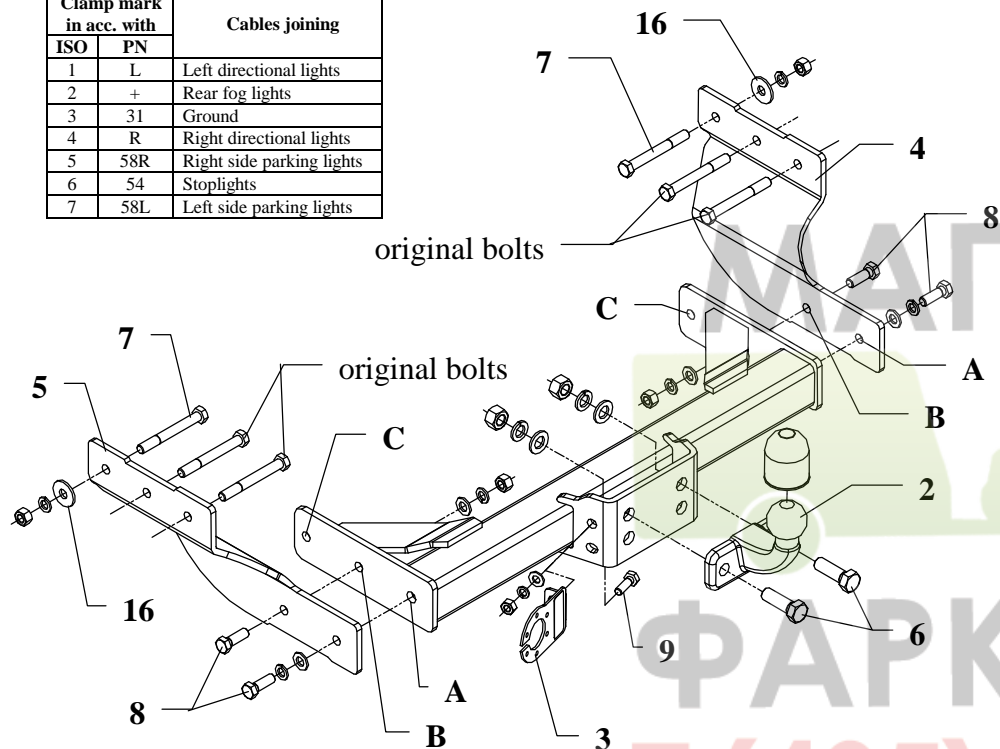

The instruction of the assembly

1. Take the spare wheel out.
2. Twist off bolts of the bumper supports from the left and right side.
3. Fix loosely side brackets (pos. 4 and 5) through the original holes in the car's frame using bolts M12x100mm (pos. 7) - four of them use from disassembled supports.
4. Put main bar of the towbar (pos. 1) between installed side brackets (pos. 4 and 5) and fix it with bolts M12x35mm (pos. 8).

Attention!

 - in models **without footboard** fix through holes pos. **A** and **B**
 - in models **with footboard** fix through holes pos. **B** and **C** (apply to both side)
5. Fix tow-ball (pos. 2) using bolts M16x50mm (pos. 6) from accessories.
6. Fix the socket plate (pos. 3) using bolt M10x30mm (pos. 9) as shown on the drawing.
7. Tighten all nuts and bolts according to the torque shown in the table
8. Connect the electric wires according to the instructions of the car
9. Complete the paint cover of towbar (during the mounting paint cover could be destroyed)

The towbar can be used in the following car:

- **FORD TRANSIT , metal built-up, with/without footboard** produced since 05.2000, catalogue no. **C35**

Max trailers dimensions 2500 kg
Max. Vertical load 75 kg

From manufacturer

Thank you for buying our product. Their reliability has been confirmed in many tests. Reliability of towbar depends also on correct assembly and right operation. For this reasons we kindly ask to read carefully this instruction and apply to hints.

The towbar should be installed in points described by a car producer.

Torque settings for nuts and bolts (8,8):

| | | |
|--------------------|---------------------|---------------------|
| M6 - 11 Nm | M8 - 25 Nm | M10 - 50 Nm |
| M12 - 87 Nm | M14 - 138 Nm | M16 - 210 Nm |











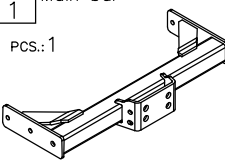
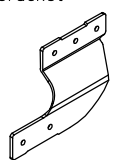





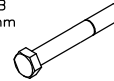

NOTE

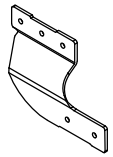
After install the towbar you should get adequate note in registration book (at authorised service station). The car should be equipped with:

- Indicators
- Tow mirrors

After 1000km check all bolts and nuts. The ball of towbar must be always kept clear and conserve with a grease.

Part list:

| | | | |
|---|---|---|---|
| Pos. 1 Main bar PCS.: 1  | Pos. 5 Left bracket PCS.: 1  | Pos. 10 Plain washer ø17mm PCS.: 2  | Pos. 16 Washer ø35xø13x3mm PCS.: 2  |
| Pos. 2 Tow ball PCS.: 1  | Pos. 6 Bolt 8,8 B M16x50mm PCS.: 2  | Pos. 11 Plain washer ø12mm PCS.: 4  | Pos. 17 Nut 8 B M16 PCS.: 2  |
| Pos. 3 Socket plate PCS.: 1  | Pos. 7 Bolt 8,8 B M12x100mm PCS.: 2  | Pos. 12 Plain washer ø10mm PCS.: 1  | Pos. 18 Nut 8 B M12 PCS.: 4  |
| Pos. 4 Right bracket PCS.: 1  | Pos. 8 Bolt 8,8 B M12x35mm PCS.: 4  | Pos. 13 Spring washer ø16,3mm PCS.: 2  | Pos. 19 Nut 8 B M10 PCS.: 1  |
| | Pos. 9 Bolt 8,8 B M10x30mm PCS.: 1  | Pos. 14 Spring washer ø12mm PCS.: 6  | Pos. 20 Ball cover PCS.: 1  |
| | | Pos. 15 Spring washer ø10mm PCS.: 1  | |



PPUH AUTO-HAK S.J.

Produkcja Zaczepów Kulowych
Henryk & Zbigniew Nejman
76-200 SŁUPSK ul. Słoneczna 16K
tel/fax (059) 8-414-414; 8-414-413
E-mail: office@autohak.com.pl
www.autohak.com.pl

Towing hitch (without electrical set)

Class: **A50-X** Cat. no. **C35**

Designed for:

Manufacturer: **FORD**

Model: **TRANSIT**

Type: **metal build-up,**
with/without plastic footboard

produced since 05.2000

Technical data:

D-value: 13,93 kN

maximum trailer weight: **2500 kg**

maximum vertical cup mass: **75 kg**

Approval number acc. to regulations EKG/ONZ 55.01: **E20-55R-01 0790**

МАГ АЗИН
ФАРКОПОВ
+7 (495) 6-693-693

Foreword

This towing hitch is designed according to rules of safety traffic regulations. The towing hitch is a safety component and can be install only by qualified personnel. Any alteration or conversion of the towing hitch is prohibited and would lead to cancellation of design certification. Remove insulating compound and underseal from vehicle (if present) in the area of the matting surfaces of the towing hitch.

The vehicle manufacturer's specifications regarding trailer mass and max. vertical cup mass are decisive for driving whereat values for the towing hitch cannot be exceeded.

D-value formula:

$$\frac{\text{Max trailer weight [kg]} \times \text{Max vehicle weight [kg]}}{\text{Max trailer weight [kg]} + \text{Max vehicle weight [kg]}} \times \frac{9,81}{1000} = D \text{ [kN]}$$